

# How To Operate

## Select Your Control Type

### IMPORTANT

This PDF is interactive. Choose the product that best fits your order, PDF will guide you to the proper installation guide. For installing refer to our “How to Install” documents.

Visual Guides 

## Need Assistance?

Contact a City Shade Associate for help.







(877)-224-8974

[support@cityshadecompany.com](mailto:support@cityshadecompany.com)

[www.cityshadecompany.com](http://www.cityshadecompany.com)

## Control Options

The control options below are for roller shade products.

-  **Continuous Loop**
-  **Twin Pull**
-  **Cordless**
-  **Wand Motor**
-  **Remote Motor**
-  **Wall Switch**

# How To Operate

## Continuous Loop And Twin Pull

### WARNING

\*According to the Window Covering Manufactures Association Inc., all labels must not be removed from the product.

\*To comply with child safety standards, all safety tension devices must be installed.

## Need Assistance?

Contact a City Shade Associate for help.

(877)-224-8974

support@cityshadecompany.com

www.cityshadecompany.com

## Continuous Loop

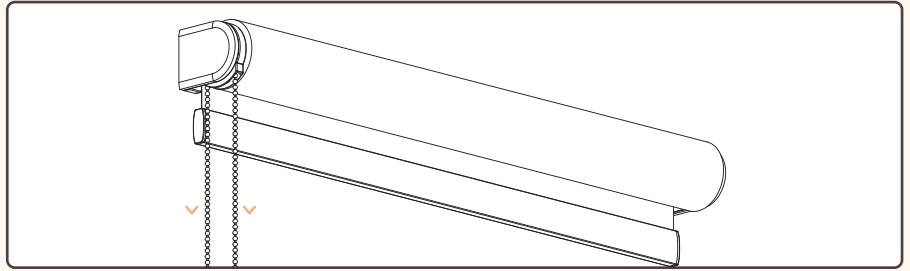

**Lower/Raise:** Continuous loop controls have a chain that loops back into the clutch. To **lower** your shade, pull down on the back of the chain. To **raise** your shade, pull down on front of the chain to lower.

## Twin Pull

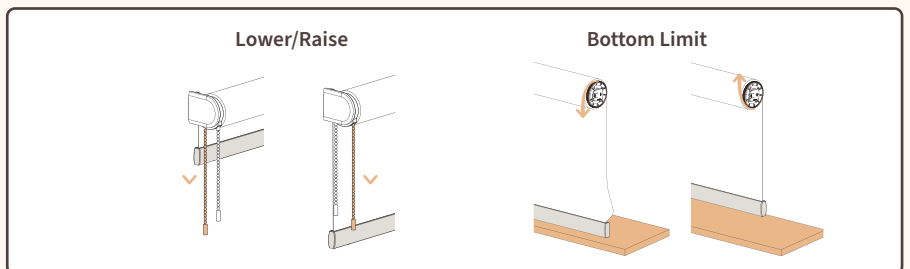

**Lower/Raise:** To lower your shade pull down on back tassel. To Raise your shade pull down on front tassel.

**Bottom Limit:** Use the back tassel to lower your shade until you reach your bottom limit.

If bottom limit is **too low**, crank the bottom limit adjuster on the opposite side of control towards you until adjuster stops

If bottom limit is **too high** turn your adjuster away from you until you reach your desired bottom limit.

# How To Operate

## Cordless

### WARNING

\*According to the Window Covering Manufactures Association Inc., all labels must not be removed from the product.

### Need Assistance?

Contact a City Shade Associate for help.  
(877)-224-8974  
support@cityshadecompany.com  
www.cityshadecompany.com

## Cordless

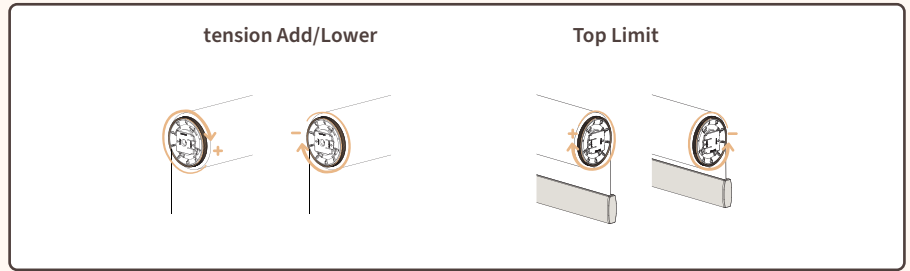

**Lower/Raise:** Lower shade by pulling to desired height, hold then pull down again ¼” to engage breaks. Raise the shade by pulling ¼” down to disengage breaks, as shade rises assist the shade up.

**Add/Decrease Tension:** If shade does not fully rise to upper limit with assistance, spring tension will need to be added. Pull shade half way down then use the tension adjuster on left side of shade. Turn the adjuster 1-2 times clock wise, then test if shade reaches upper limit. Repeat if necessary.

**Top Limit:** Set top limit by turning the adjuster on right of shade clockwise to raise or counter clock wise to lower upper limit. Before adjusting start from the shades upper most limit.

# How To Operate

## Wand Motor

### WARNING

\*According to the Window Covering Manufacturers Association Inc., all labels must not be removed from the product.

## Need Assistance?

Contact a City Shade Associate for help.  
 (877)-224-8974  
[support@cityshadecompany.com](mailto:support@cityshadecompany.com)  
[www.cityshadecompany.com](http://www.cityshadecompany.com)

## Activating Motor

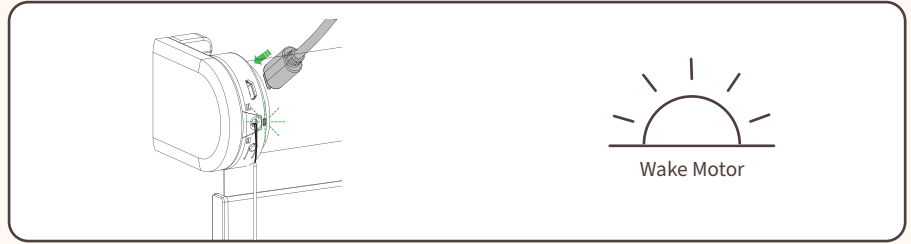

**Activating Motor:** When shipping the shade will be placed in a sleep mode. Wake up shade by connecting the charger to the shade motor.

## Operating Shade

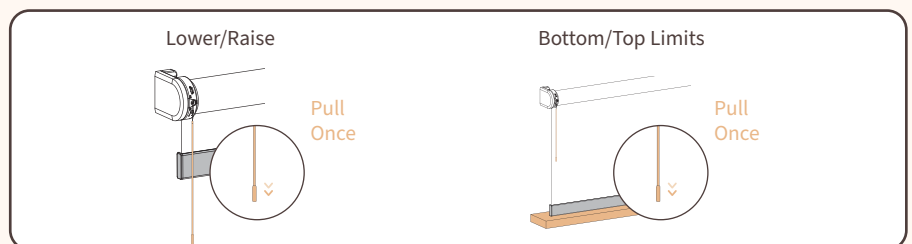

**Lower/Raise:** Lower shade by pulling once on wand to lower an again to stop. To raise shade pull once on wand and to stop pull once more.

**Bottom/Top Limit:** Access top and or bottom limit by pulling down on wand once. If shade is moving to the opposite limit you desire, pull wand to stop then pull wand again to change direction.

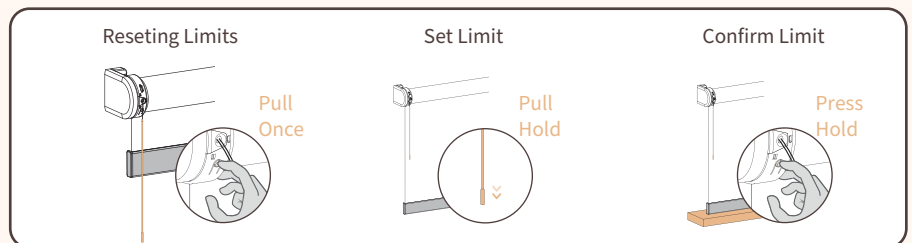

**Resetting Limits:** Reset limits by pressing the program button on shade motor. The shade will jog up and down, continue to hold until shade jogs up and down for a second time. New limits are now ready to be set.

**Set New bottom Limit:** Pull and hold wand until shade reaches your desired bottom limit. Once stopped, press and hold program button on motor until shade jogs.

**Set New Top Limit:** Pull and hold wand until shade reaches your desired top limit. Once stopped, press and hold program button on motor until shade jogs.

# How To Operate

## Remote

## Need Assistance?

Contact a City Shade Associate for help.

(877)-224-8974

support@cityshadecompany.com

www.cityshadecompany.com

## Activating Motor

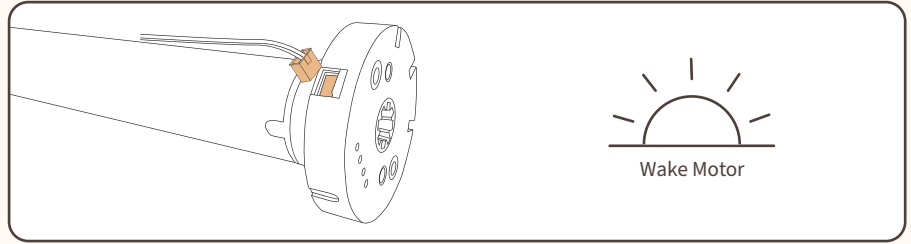

**Activating Motor:** When shipping the shade will be placed in a sleep mode. Wake up shade by connecting the motor to the charger. The shade will briefly jog up/down. Motor will now operate with programmed transmitter.

## Understanding Channels

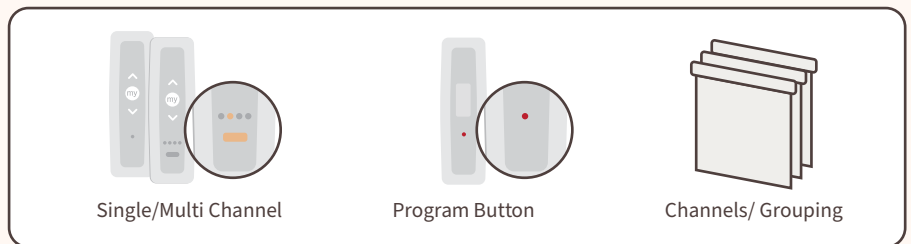

**Single/Multi Channel:** There are two options when choosing a remote. Single or multi channels.

**Program Button:** The program button can be found on back of the remote. You will need access to this button as you pair shades and add channels to your remote.

**Channels/Grouping:** Shades can be set individually to a channel or can be grouped to a channel.

**Choosing Channels:** There are five channels, LED 1-4 will illuminate individually as you choose through channel 1-4. The 5th channel is selected when all LED lights are flashing. The 5th Channel is set to control all shades paired with that remote.

## Limit Settings

Once shade is installed check to make sure the top and bottom limits are set correctly. Lower the shade to the bottom limit, then raise shade to the top limit. If shade limits need to be adjusted proceed to the following instructions.

# How To Operate

## Remote

## Understanding Channels

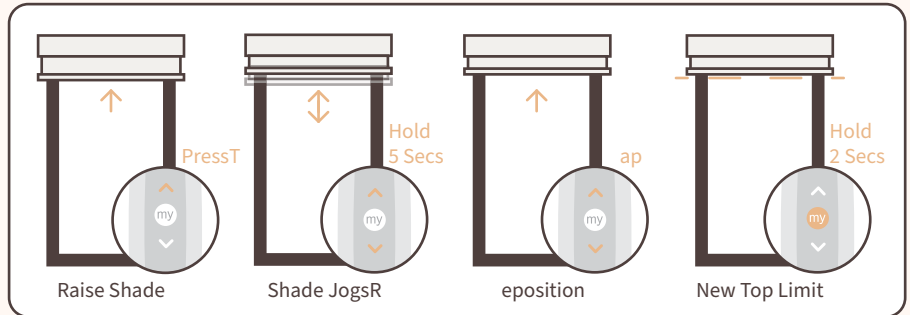

**Setting Top Limit:** To adjust the top limit, raise the shade to the preset top position. Press and hold the up and down button simultaneously until the shade jogs. Reposition the shade to the desired top limit. Press and hold the My button for 2 secs to confirm the new bottom position. The shade will then jog, confirming position.

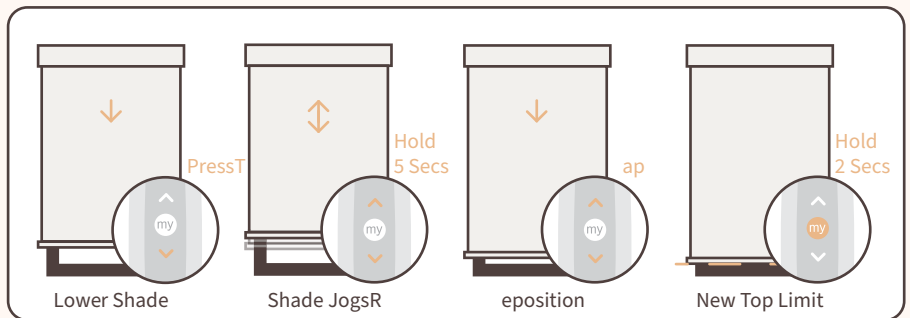

**Setting Bottom Limit:** To adjust the bottom limit, lower the shade to the preset bottom position. Press and hold the up and down button simultaneously until the shade jogs. Reposition the shade to the desired bottom limit. Press and hold the My button for 2 secs to confirm the new bottom position. The shade will then jog, confirming position.

## Favorite Position

**Favorite Position:** Set by pressing up or down button to bring shade to desired favorite position, use My button to stop shade at favorite position. Once stopped, hold My button until shade briefly moves up and down. To go to your favorite position, shade must be stopped, then press My button.

*If your shades are programmed to your satisfaction, there are no further steps necessary.*

To add or delete shades to other channels on the remote control or group shades together, see the following instructions.

## Need Assistance?

Contact a City Shade Associate for help.

(877)-224-8974

support@cityshadecompany.com

www.cityshadecompany.com

# How To Operate

## Remote

### Adding & Deleting Channels /Grouping

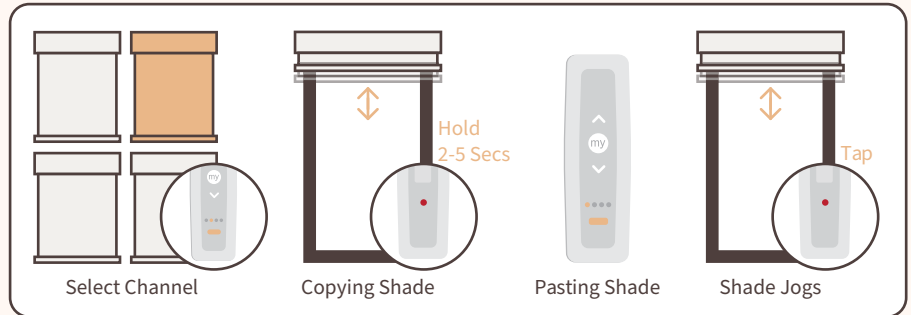

**Adding Shades To Channels:** To add a shade to a channel. Select the channel that your shade is currently programmed to. Press the program button on the back of the remote for 2-5 seconds. The shade will jog. Program within 2 mins or shade will reset to factory settings.

Follow with selecting the channel you would like to program the shade to, then quickly press and release the program button on the back of the remote. When done correctly the shade will jog. Follow the same procedure to group multiple shades to the channel.

**Deleting Shades From Channel:** To delete a shade, select the channel where the shade was originally programmed. Press and hold the button on the back of the remote for 2-5 seconds. The shade will jog. Select the channel you would like to delete the shade from, then press and release the program button on the back of the remote. When done correctly the shade will jog again.

## Need Assistance?

Contact a City Shade Associate for help.

(877)-224-8974

[support@cityshadecompany.com](mailto:support@cityshadecompany.com)

[www.cityshadecompany.com](http://www.cityshadecompany.com)

# How To Operate

## Wall Switch

## Activating Motor

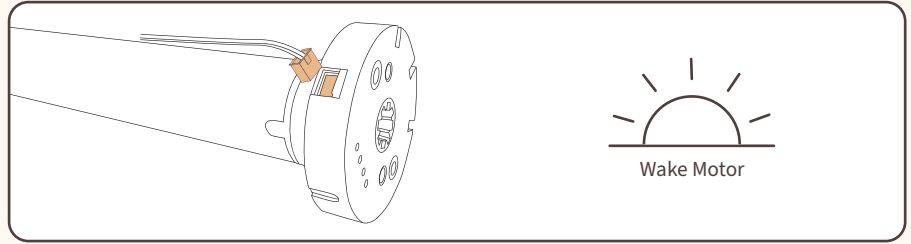

**Activating Motor:** When shipping the shade will be placed in a sleep mode. Wake up shade by connecting the motor to the charger. The shade will briefly jog up/down. Motor will now operate with programed transmitter.

## Understanding Channels

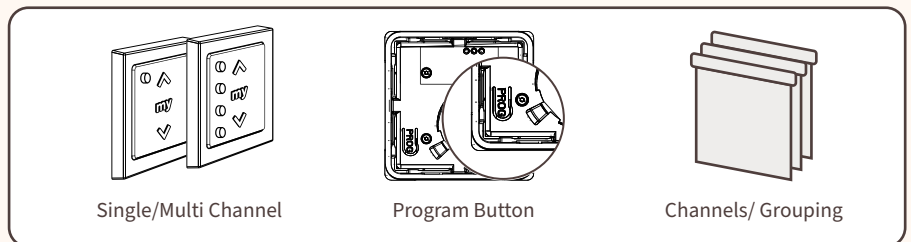

**Single/Multi Channel:** There are two options when choosing a remote. Single or multi channels.

**Program Button:** The program button can be found on back of the remote. You will need access to this button as you pair shades and add channels to your remote.

**Channels/Grouping:** Shades can be set individually to a channel or can be grouped to a channel.

**Choosing Channels:** There are four channels, LED 1-4 will illuminate individually as you choose through channel 1-4. Select multiple channels to operate together.

## Limit Settings

Once shade is installed check to make sure the top and bottom limits are set correctly. Lower the shade to the bottom limit, then raise shade to the top limit. If shade limits need to be adjusted proceed to the following instructions.

## Need Assistance?

Contact a City Shade Associate for help.

(877)-224-8974

[support@cityshadecompany.com](mailto:support@cityshadecompany.com)

[www.cityshadecompany.com](http://www.cityshadecompany.com)



# How To Operate

## Wall Switch

### Understanding Channels

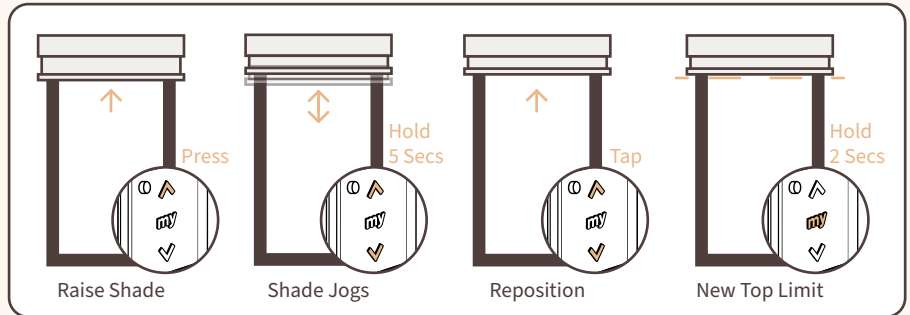

**Setting Top Limit:** To adjust the top limit, raise the shade to the preset top position. Press and hold the up and down button simultaneously until the shade jogs. Reposition the shade to the desired top limit. Press and hold the My button for 2 secs to confirm the new bottom position. The shade will then jog, confirming position.

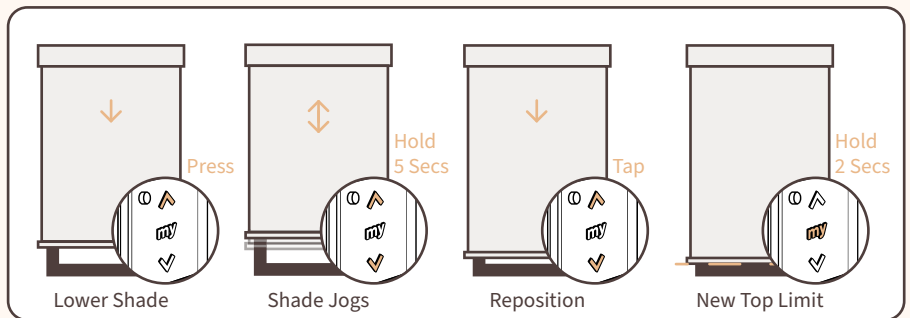

**Setting Bottom Limit:** To adjust the bottom limit, lower the shade to the preset bottom position. Press and hold the up and down button simultaneously until the shade jogs. Reposition the shade to the desired bottom limit. Press and hold the My button for 2 secs to confirm the new bottom position. The shade will then jog, confirming position.

### Favorite Position

**Favorite Position:** Set by pressing up or down button to bring shade to desired favorite position, use My button to stop shade at favorite position. Once stopped, hold My button until shade briefly moves up and down. To go to your favorite position, shade must be stopped, then press My button.

### Need Assistance?

Contact a City Shade Associate for help.

(877)-224-8974

support@cityshadecompany.com

www.cityshadecompany.com

*If your shades are programed to your satisfaction, there are no further steps necessary.*

To add or delete shades to other channels on the remote control or group shades together, see the following instructions.

# How To Operate

## Wall Switch

### Adding & Deleting Channels /Grouping

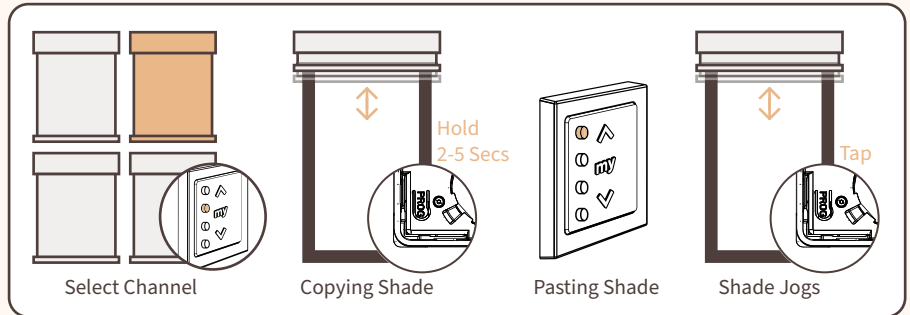

**Adding Shades To Channels:** To add a shade to a channel. Select the channel that your shade is currently programmed to. Press the program button on the back of the remote for 2-5 seconds. The shade will jog. Program within 2 mins or shade will reset to factory settings.

Follow with selecting the channel you would like to program the shade to, then quickly press and release the program button on the back of the remote. When done correctly the shade will jog. Follow the same procedure to group multiple shades to the channel.

**Deleting Shades From Channel:** To delete a shade, select the channel where the shade was originally programmed. Press and hold the button on the back of the remote for 2-5 seconds. The shade will jog. Select the channel you would like to delete the shade from, then press and release the program button on the back of the remote. When done correctly the shade will jog again.

### Installing Wall Switch

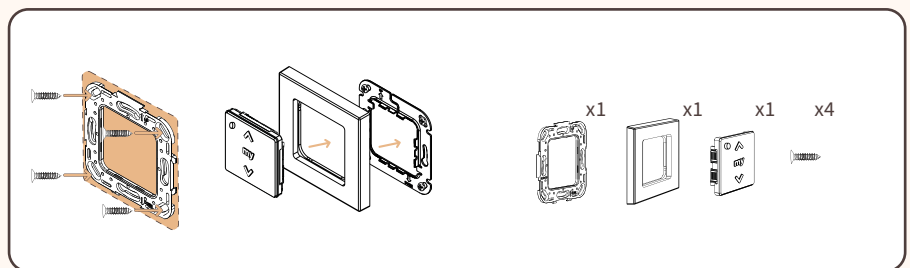

Begin installation of wall switch by installing the mounting bracket with each of the 4 provided countersunk screws. (Installing wall switch near a metal frame will impact performance of remote.)

Complete installation by snapping frame on to the mounted bracket, then clip the wall switch in to the frame.

### Need Assistance?

Contact a City Shade Associate for help.

(877)-224-8974

support@cityshadecompany.com

www.cityshadecompany.com