

# How To Install

## Select Your Roller Shade

### IMPORTANT

This PDF is interactive. Choose the product that best fits your order, PDF will guide you to the proper installation guide. For control options refer to our “How to Operate” document.

Visual Guides 

## Roller Shade Selections

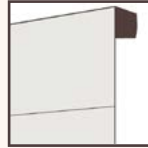

**Slim Fit**



**Slim Fit TDBU**



**Cordlock**

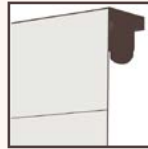

**Classic Wood**

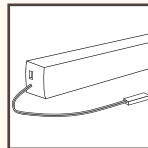

**Rechargeable Battery Pack**

# How To Install

## Slim Fit

### WARNING

\*According to the Window Covering Manufacturers Association Inc., all labels must not be removed from the product.

\*To comply with child safety standards, all tension devices must be installed.

[Click](#) for Tension Device Guide

## Tools Needed

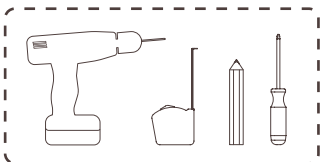

## Need Assistance?

Contact a City Shade Associate for help with Installing.

(877)-224-8974

support@cityshadecompany.com

www.cityshadecompany.com

## Installing Brackets

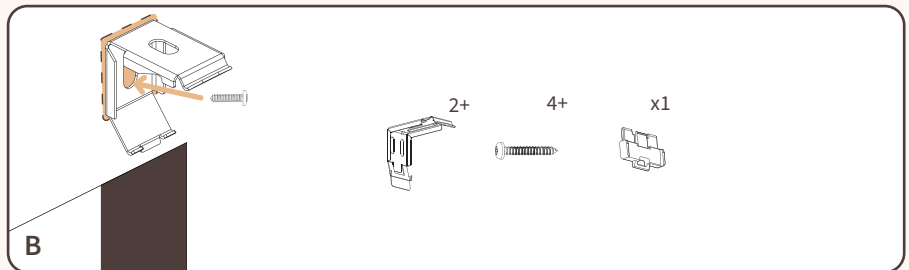
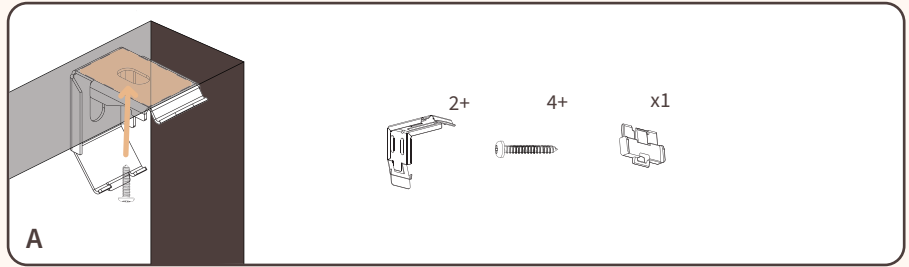

**A. Inside Mount:** Place brackets minimum 2" from the side frame.

**B. Outside Mount:** Measure the total width of shade, then center over the window frame. Place the brackets minimum of 2" in from each end. We recommend installing 3" above window frame.

Brackets must be securely attached to the mounting surface. If the screws provided do not hit wood studs you'll have to use a different fastener which can be found at any hardware store.

**NOTE:** Keep the roller shade up-rolled, do not unroll before installation.

## Installing Shade

*illustration displayed without shade for demonstration only.*

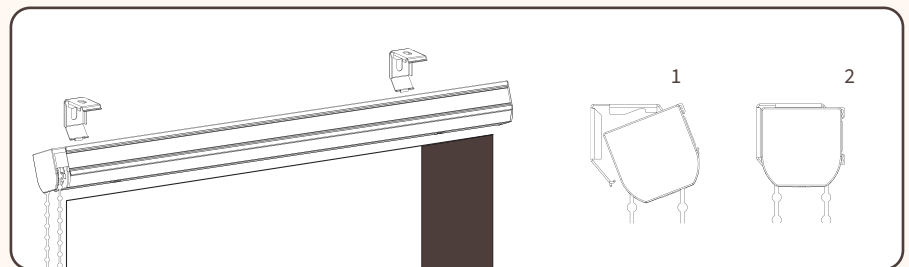

Begin with sliding shade in back end lowered with back end lowered enough for lip of bracket to make contact with lip on top of cassette. Once contact is made beg in to lift back end up until you hear a click.

Then place stability block on chain side between mount and wall.

# How To Install

## Slim Fit

### WARNING



\*Young children can strangle in the loop of pull cords, chains and tapes, and cords that operate window coverings.

\*To avoid strangulation and entanglement, keep cords out of the reach of young children. Cords may become wrapped around a child's neck

\*Do not tie cords together. Make sure cords do not twist together and form a loop.

[Click](#) for Tension Device Guide

## Need Assistance?

Contact a City Shade Associate for help with Installing.

(877)-224-8974

[support@cityshadecompany.com](mailto:support@cityshadecompany.com)

[www.cityshadecompany.com](http://www.cityshadecompany.com)

## Installing Slim Flit Motorized

*illustration displayed without shade for demonstration only.*

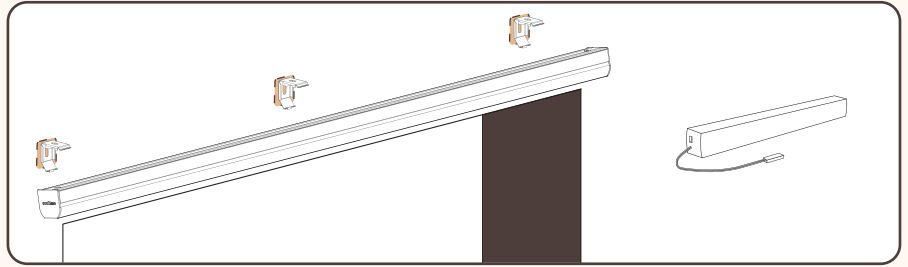

Slim Fit Motorized headrail is installed the same way as Slim Fit. When installing motorized version you must also install [Battery Pack](#).

# How To Install

## Slim Fit TDBU

### WARNING

\*According to the Window Covering Manufacturers Association Inc., all labels must not be removed from the product.

\*To comply with child safety standards, all tension devices must be installed.

[Click](#) for Tension Device Guide

### Tools Needed

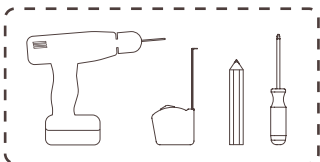

### Need Assistance?

Contact a City Shade Associate for help with Installing.

(877)-224-8974

support@cityshadecompany.com

www.cityshadecompany.com

## Installing Brackets

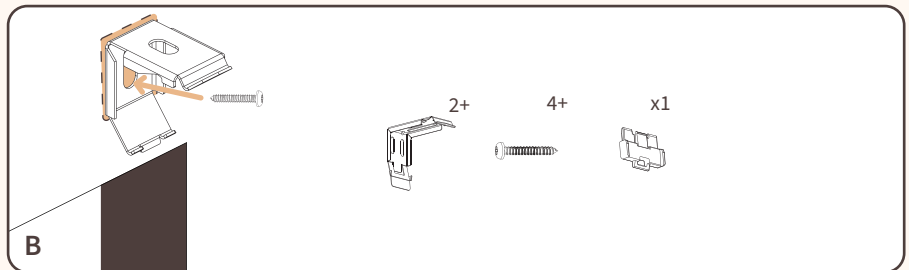
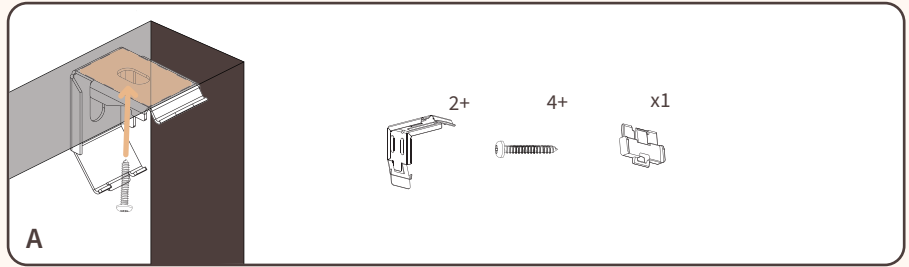

**A. Inside Mount:** Install brackets minimum of 2" from the side of the window frame.

**B. Outside Mount:** Measure the total width of shade, then center over the window frame. Place the brackets minimum of 2" in from each end. We recommend installing 3" above window frame.

For longer shades, more than 2 brackets will be included. Install additional brackets spaced evenly between each other.

Brackets must be securely attached to the mounting surface. If the screws provided do not hit wood studs you'll have to use a different fastener which can be found at any hardware store.

**NOTE:** Do not unroll shade before installation.

## Installing Shade

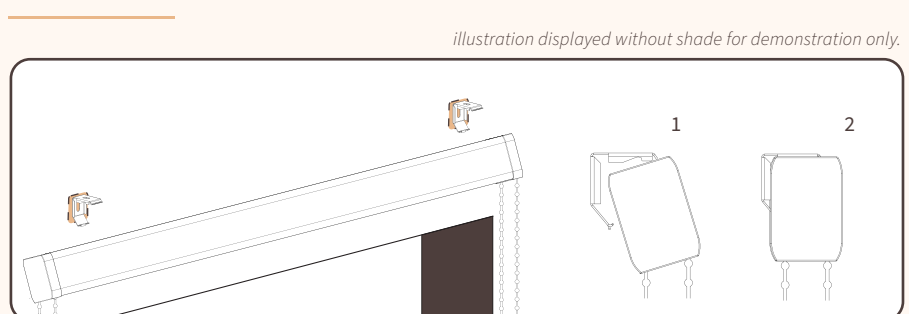

Slide the shade in to the brackets with back end of headrail at an angle. Allow the front lip of bracket to slide under the front lip of the top of the headrail. Then press the back of headrail up firmly in to the bracket until you hear a click.

# How To Install

## Slim Fit Cordlock

### WARNING

\*According to the Window Covering Manufacturers Association Inc., all labels must not be removed from the product.

\*To comply with child safety standards, all tension devices must be installed.

[Click](#) for Tension Device Guide

## Tools Needed

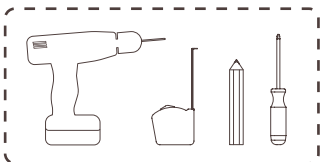

## Need Assistance?

Contact a City Shade Associate for help with Installing.

(877)-224-8974

support@cityshadecompany.com

www.cityshadecompany.com

## Installing Brackets

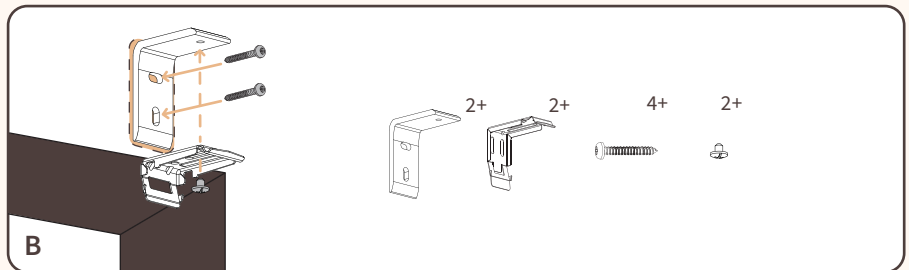
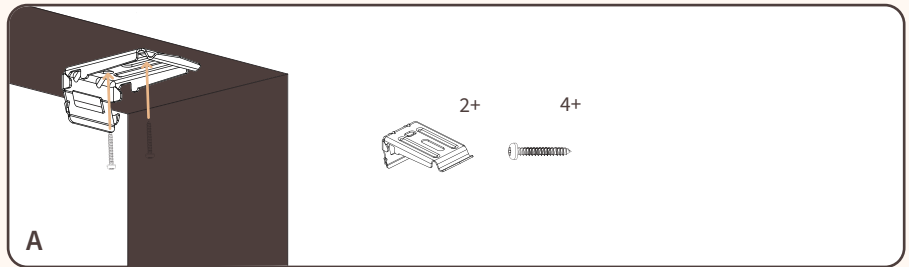

**A. Inside Mount:** Place brackets minimum 3" from the side frame.

**B. Outside Mount:** Measure the total width of shade, then center over the window frame. Install bracket supports then install brackets in to supports using provided short screw. We recommend installing 3" from each end of measurement and above window frame.

Brackets must be securely attached to the mounting surface. If the screws provided do not hit wood studs you'll have to use a different fastener which can be found at any hardware store.

**NOTE:** Keep the shade up-rolled, do not unroll before installation.

## Installing Shade

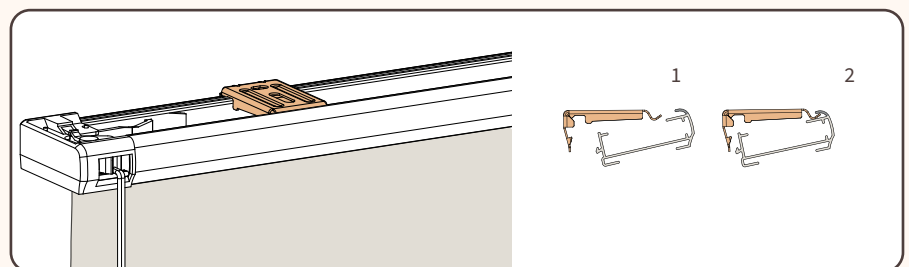

Begin with sliding shade in back end lowered with back end lowered enough for lip of bracket to make contact with lip on top of cassette. Once contact is made beg in to lift back end up until you hear a click.

Then place stability block on chain side between mount and wall.

# How To Install

## Classic Wood

### WARNING

\*According to the Window Covering Manufacturers Association Inc., all labels must not be removed from the product.

\*To comply with child safety standards, all tension devices must be installed.

[Click](#) for Tension Device Guide

### Tools Needed

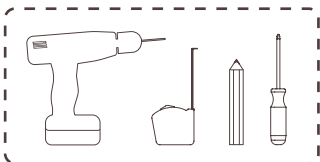

### Need Assistance?

Contact a City Shade Associate for help with Installing.

(877)-224-8974

support@cityshadecompany.com

www.cityshadecompany.com

## Installing Brackets

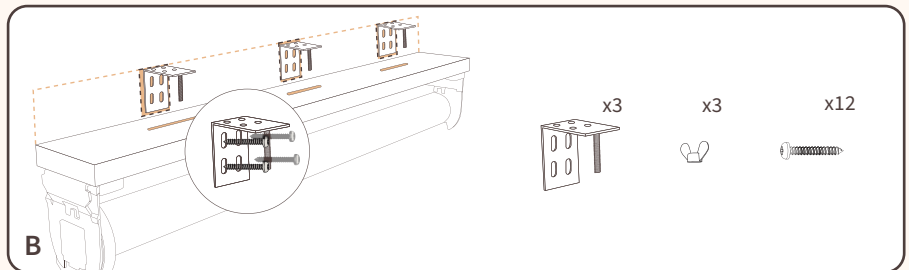
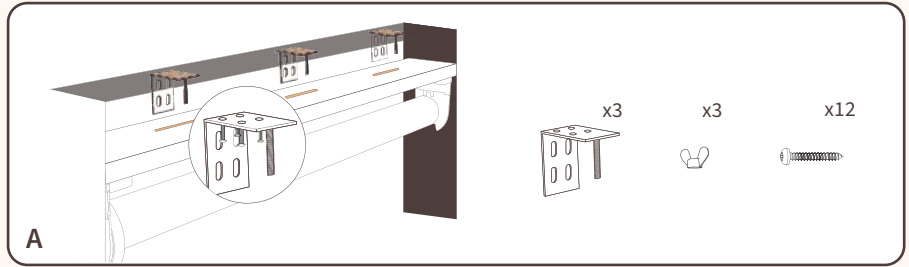

**A. Inside Mount:** Measure from the left end of board to the middle of left slot. This is the distance you will want to center and install your bracket from left side of window casement. Repeat process for middle and right brackets. For mounting shade flush to window casement, do not install bracket within a minimum of .75" of outer end of window casement.

**B. Outside Mount:** Center shade over the window casement and mark each end of the board on the wall. Remove the shade and measure from left end of board to the middle of left slot. This is the distance you will want to center and install your bracket from the marking on the wall. Repeat Process for the middle and right brackets. We recommended installing 3" above window.

If the screws provided do not hit wood studs you'll have to use a different fastener which can be found at any hardware store.

**NOTE:** Keep the shade up-rolled, do not unroll before installation.

## Installing Shade

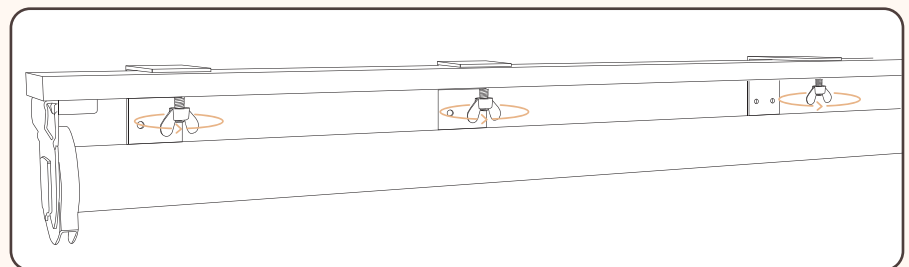

Use wing nuts to secure board to brackets. We recommend double checking your shade is centered. If not centered slightly loosen wingnuts and slide left or right until centered then re-tighten.

# How To Install

## Safety Tension Device

### WARNING



\*Young children can strangle in the loop of pull cords, chains and tapes, and cords that operate window coverings.

\*To avoid strangulation and entanglement, keep cords out of the reach of young children. Cords may become wrapped around a child's neck

\*Do not tie cords together. Make sure cords do not twist together and form a loop.

## Need Assistance?

Contact a City Shade Associate for help with Installing.

(877)-224-8974

[support@cityshadecompany.com](mailto:support@cityshadecompany.com)

[www.cityshadecompany.com](http://www.cityshadecompany.com)

## Installing Tension Bracket

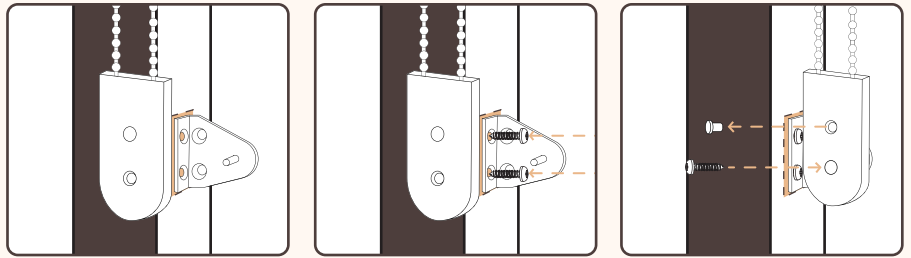

**Step 1:** Pull tension device down to where there is very little slack. Mark the area where the bracket sits.

**Step 2:** When placed in the correct spot, use two screws to secure bracket.

**Step 3:** Place tension device on to bracket, secure with a screw and remove stopper from top hole.

# How To Install

## Remote Motor Battery Pack

### Items Needed

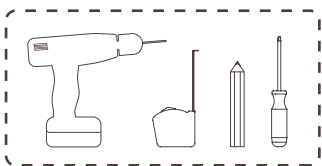

### Need Assistance?

Contact a City Shade Associate for help with Installing.

(877)-224-8974

support@cityshadecompany.com

www.cityshadecompany.com

## Mounting Battery

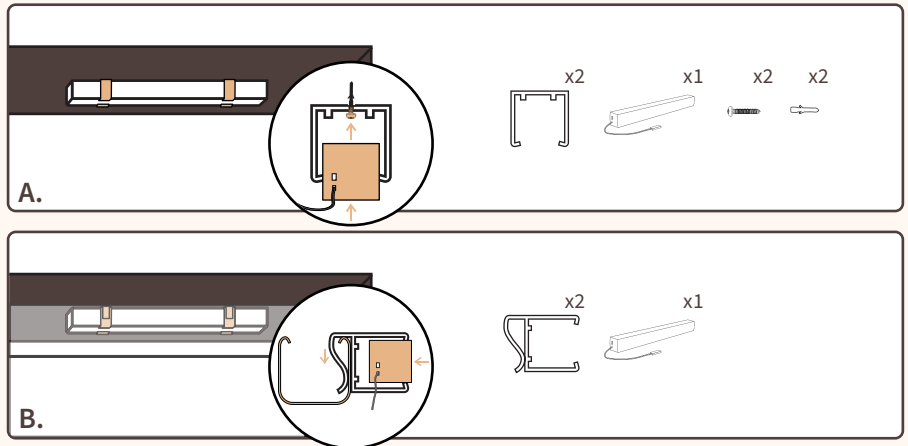

**A. Wall/Ceiling Mount:** Using the bracket with the screw slot, install battery behind shade and directly in to window casement. Make sure to use anchors if driving screws directly in to dry wall.

Once brackets are spaced evenly and secured in window casement, snap your battery in to the bracket. The battery is installed properly when bracket has a firm grip around the battery.

Please note battery must be installed within range of motor.

**B. Head Rail Mount:** Using the bracket with the clip, install battery behind shade and on to the headrail. This mount will not need screws. However, brackets are safely installed when the clip has a snug fit on headrail. The battery is installed properly when bracket has a firm grip around the battery.

## Connecting & Charging

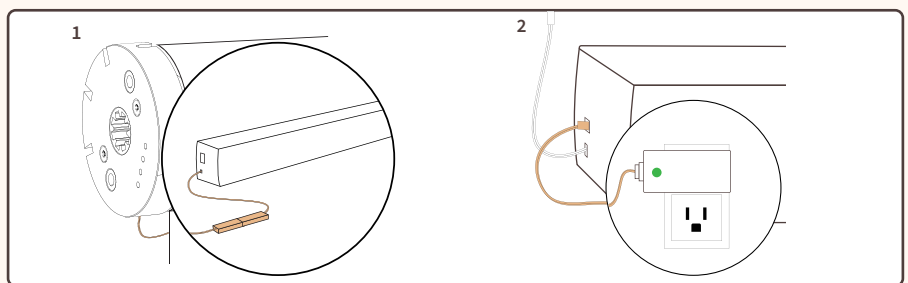

Power the motor by connecting the two existing cables from the motor and the battery together. To charge the battery, plug in the provided charger to a nearby outlet and plug charging cord in to charging port of battery. (Disconnect battery from motor if provided charger does not reach.)

Orange LED light on charger will remain red when charging and green when fully charged.